

BLE Module

MS56SFA

Datasheet

V 1.1.0

Applicable Product Model
MS56SFA-IN610
MS56SFA-IN628E

Version Note

Version	Details	Contributor(s)	Date	Notes
1.0.0	First edit	Michelle	2023.11.23	
1.1.0	New Products MS56SFA-IN628E	Michelle	2024.04.02	

MS56SFA-IN610

Industry leading cost versus performance ratio, Ultra-low power, Bluetooth module supporting simultaneous connection of 5 BLE devices



PCB

The MS56SFA is a highly flexible, ultra-low power, cost-effective Bluetooth 5 compliant Bluetooth module based on the IN610. Its powerful Arm® Cortex®-M4F CPU with a core running speed of 64Mhz, in addition, it comes with 512kB FLASH program space, 256 KB ROM, 96 KB SRAM and 4 KB eFuse memory. The hardware supports two VDDIO individual power supply control, supporting five Bluetooth devices to connect simultaneously, while the ultra-low system power consumption and excellent RF performance, as well as other powerful supporting resources for Bluetooth connectivity to provide the perfect solution.

■ Features

- Industry leading cost versus performance ratio
- Ultra-low power
- Supports simultaneous connection of 5 BLE devices
- Supports optional external antenna

■ Application

- Smart lighting
- Smart lock
- Industrial internet
- Intelligent medical care
- Toys
- Function switches

■ Key parameter

Chip Model	INPLAY-IN610	Antenna	PCB
Module Size	23.2×17.4×2mm	GPIO	24
Flash	512KB	RAM	256 KB ROM 96 KB SRAM
Receiving Sensitivity	-104.5dBm (125kbps) -97.5dBm(1Mbps)	Transmission Power	-35 ~ +3dBm
Current(TX)	0dBm- 4.1mA	Current(RX)	5mA

MS56SFA-IN628E

Ultra-low latency, Industry leading cost versus performance ratio, Synchronized multi-node Bluetooth modules

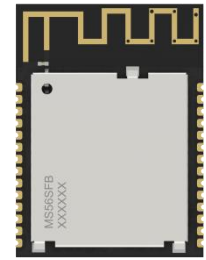

PCB

The MS56SFA-IN628E is a highly flexible, cost-effective module with a synchronous multi-node low-latency (SMULL) stack based on the IN628E, integrating both the 2.4G band and the MCU system. Its powerful Arm® Cortex®-M4F CPU with cores running at 64Mhz, in addition to 512kB FLASH program space, 384 KB ROM and 184 KB SRAM, has 4 KB of eFuse memory and a well-designed hardware security engine supporting AES128, AES256, SHA-1, AES128, AES256, SHA-1, SHA-2 and ECC encryption and decryption algorithms, as well as other powerful supporting resources provide the perfect solution for synchronous connectivity.

■ Features

- Ultra-low latency, Bi-directional synchronous communication
- Supports optional external antenna
- Up to 128 nodes in a single network with InPlay SMULL engine
- Hardware security engine with support for AES128, AES256, SHA-1, SHA-2 and ECC encryption and decryption algorithms

■ Application

- Smart home
- Smart classrooms
- Low latency wireless audio
- Game accessories
- Industrial robot

■ Key parameter

Chip Model	INPLAY-IN628E	Antenna	PCB
Module Size	23.2×17.4×2mm	GPIO	24
Flash	512KB	RAM	384 KB ROM 184 KB SRAM
Receiving Sensitivity	-97.5dBm (1Mbps) -94.5dBm(2Mbps)	Transmission Power	-35~+3dBm
Current(TX)	0dBm-4.1mA	Current(RX)	5mA

INDEX

1 Block Diagram	6
1.1 MS56SFA-IN610	6
1.2 MS56SFA-IN628E	6
2 Electrical Specification	7
3 Pin Description	8
4 Pin Definition	9
5 Mechanical Drawing	11
6 Electrical Schematic	12
7 PCB Layout	13
8 Reflow and Soldering	15
9 Package Information	16
10 Ordering Information	17
● Quality	18
● Contact Us	18
● Copyright Statement	19

1 Block Diagram

1.1 MS56SFA-IN610

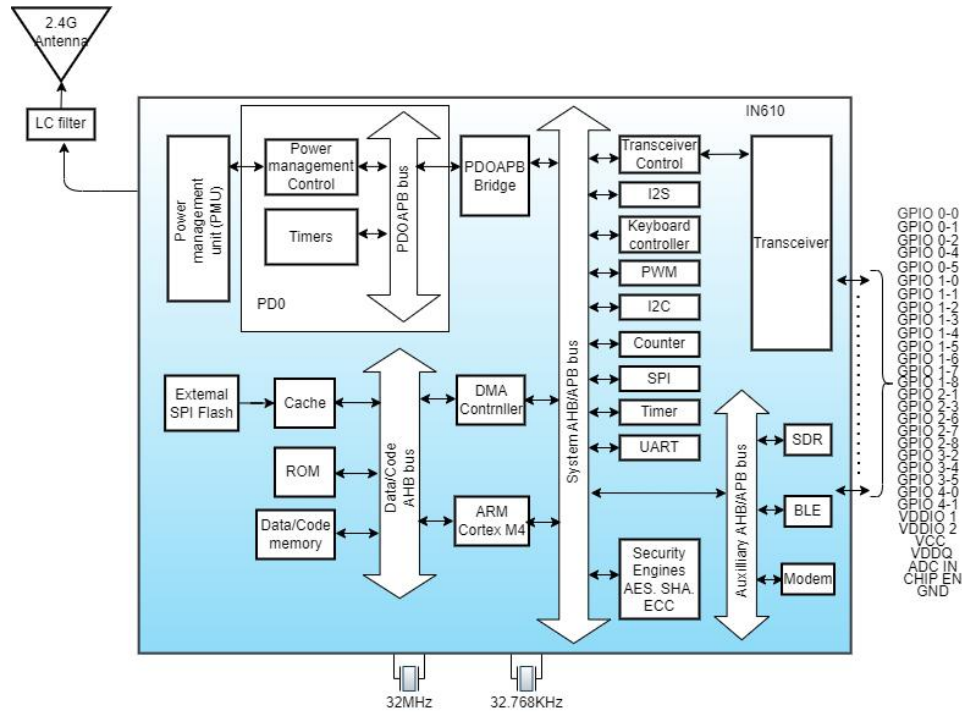

1.2 MS56SFA-IN628E

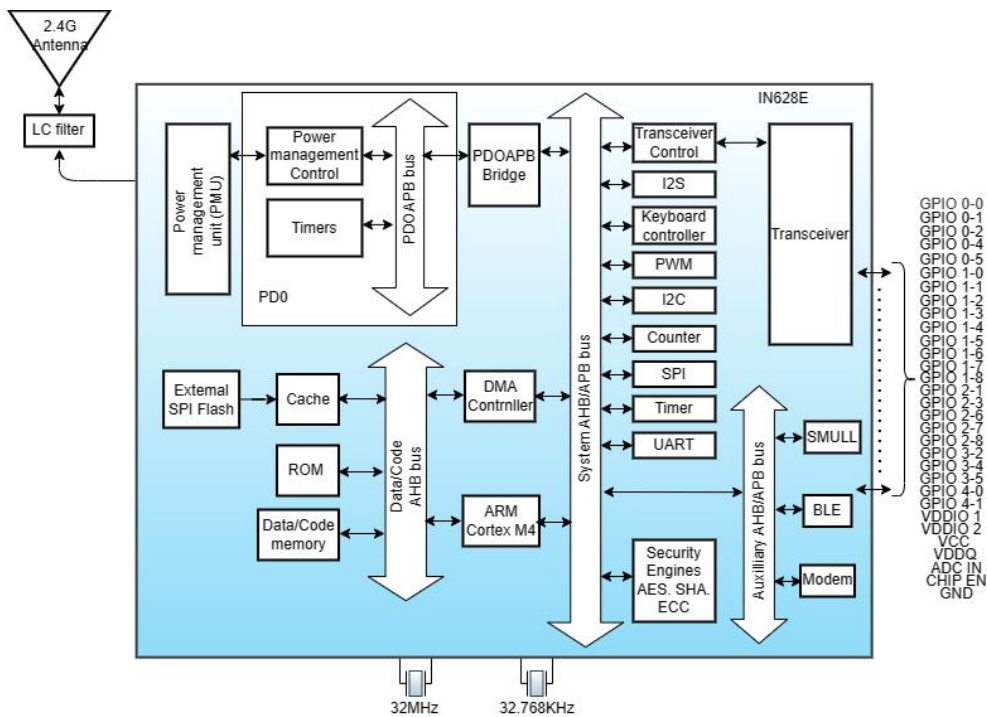

2 Electrical Specification

Parameter	Values	Notes
Working Voltage	1.7V-3.6V	To ensure RF work, supply voltage suggest not lower than 2.3V
Working Temperature	-40°C~+85°C	Storage temperature is -40°C~+105°C
Transmission Power	-35 ~ +3dBm	Configurable
Current(RX)	5mA	RF receiving current under 1Mbps pattern
Current(TX)	1.4mA	RF transmission current under odB pattern
Module Dimension	23.2*17.4*2mm	
Quantity of IO Port	24	

3 Pin Description

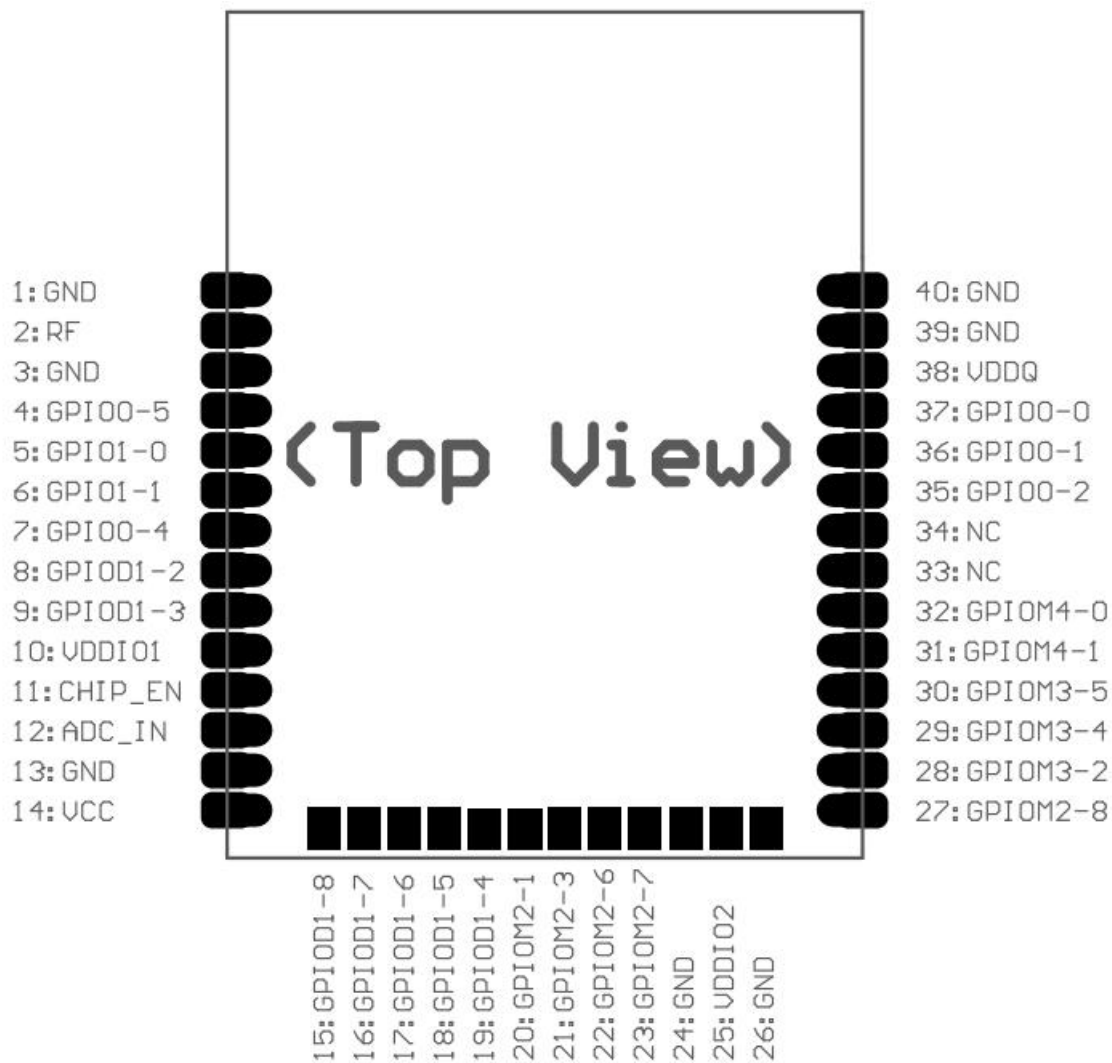

4 Pin Definition

Pin Number	Symbol	Type	Definition
1/3/13/24/ 26/39/40	GND	Negative Power	GND
2	RF	External Antenna Pin	By default, the module comes with an antenna, this pin is directly suspended. If you don't use the module antenna, you can connect an external antenna through this pin, when connecting an external antenna, the module needs to connect the resistor with the antenna to this pin; you need to explain the configuration requirements with the salesperson.
4-9	GPIO0-5/GPIO1-0/ GPIO1-1/GPIO0-4/ GPIOD1-2/GPIOD1-3	Digital inputs/outputs	Digital signal GPIO, pin multiplexing is detailed in the chip datasheet; Where GPIO1-1/GPIO1-2 can be used as JTAG burn pins; GPIO1-1: JTAG TMS or SWD I/O signals; GPIO1-2: JTAG or SWD clock input (TCK/SCK)
10	VDDIO1	I/O Power Supply	I/O supply voltage for GPIOD_1, 1.7V-3.6V; configurable off in sleep mode to reduce leakage power
11	CHIP-EN	Reset pin	Can be used to enable or disable the device. Enable: "High" $\geq 0.7V_{BAT}$; Shutdown: "Low" $\leq 0.3V_{BAT}$; Reset (temporary disable and re-enable) during operation toggles the pin and holds it "low" for at least 100 seconds, with a "high" rise time of less than 5 ms.
12	ADC-IN	PMU	Sensor ADC input
14	VCC	Positive Power	Power supply, 1.7V-3.6V with this pin
15-23	GPIOD1-8/GPIOD1-7/ GPIOD1-6/GPIOD1-5/ GPIOD1-4/GPIOM2-1/ GPIOM2-3/GPIOM2-6/ GPIOM2-7	GPIO_0/GPIOD_1 digital input/output; GPIOM_2 mixed-signal inputs/outputs	Digital signal GPIO; Mixed-signal GPIO, pin-multiplexing details see chip specification; Among them, GPIOD1-7/GPIOM2-1/GPIOM2-3 can be used as UART1 TX; GPIOD1-8/GPIOM2-7 can be used as UART1 RX; When using UART1 TX and UART1 RX to power up, you need to pull down the GPIOM2-6 boot pin

25	VDDIO2	I/O Power Supply	I/O supply voltage for GPIOM_2, 1.7V-3.6V; configurable off in sleep mode to reduce leakage power
27-32	GPIOM2-8/GPIOM3-2/ GPIOM3-4/GPIOM3-5/ GPIOM4-1/GPIOM4-0	GPIOM_2 mixed-signal input/output. GPIOM_3/GPIOM_4 digital input/output.	Digital signal GPIOs; mixed signal GPIOs, pin-multiplexing see chip datasheet for details
33/34	NC	NC	NC
35-37	GPIO0-2/GPIO0-1/ GPIO0-0	Digital inputs/outputs	Digital signal GPIOs, pin-multiplexed as detailed in the chip datasheet
38	VDDQ	Supply Power	aFuse Programming Supply Voltage 3.3V

Note: 1, VDDIO1/VDDIO2 supplies power to stacked flash memory and external circuits (such as sensors). In order to facilitate use and testing, the hardware default VDDIO1/VDDIO2 has been connected to the VCC pin. If you need to call the power supply separately, please confirm the configuration with the salesperson from MinewSemi;

2, The module chip integrated 4KB eFuse memory, can be used as a security key storage, etc., once the eFuse memory is programmed and locked, the contents of the memory will be permanently valid, can not be modified or changed.

5 Mechanical Drawing

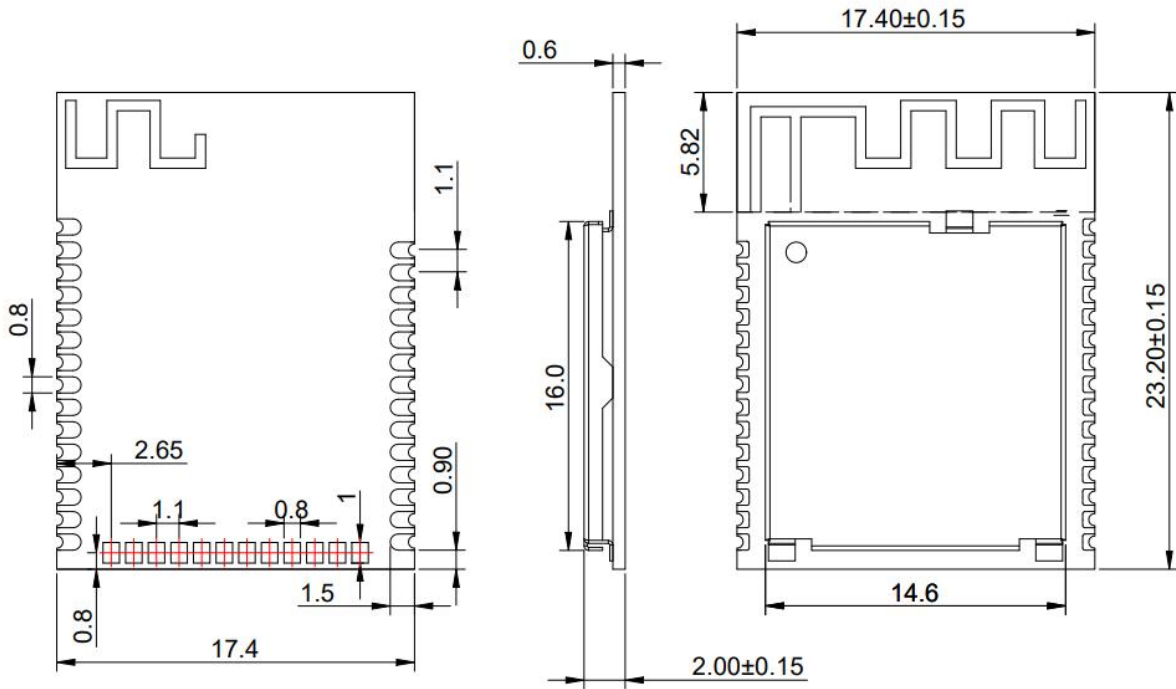

* (Default unit: mm Default tolerance: ±0.1)

Notice: The recommended pad size is 1.8*0.8mm with a pad extension of 0.5mm

6 Electrical Schematic

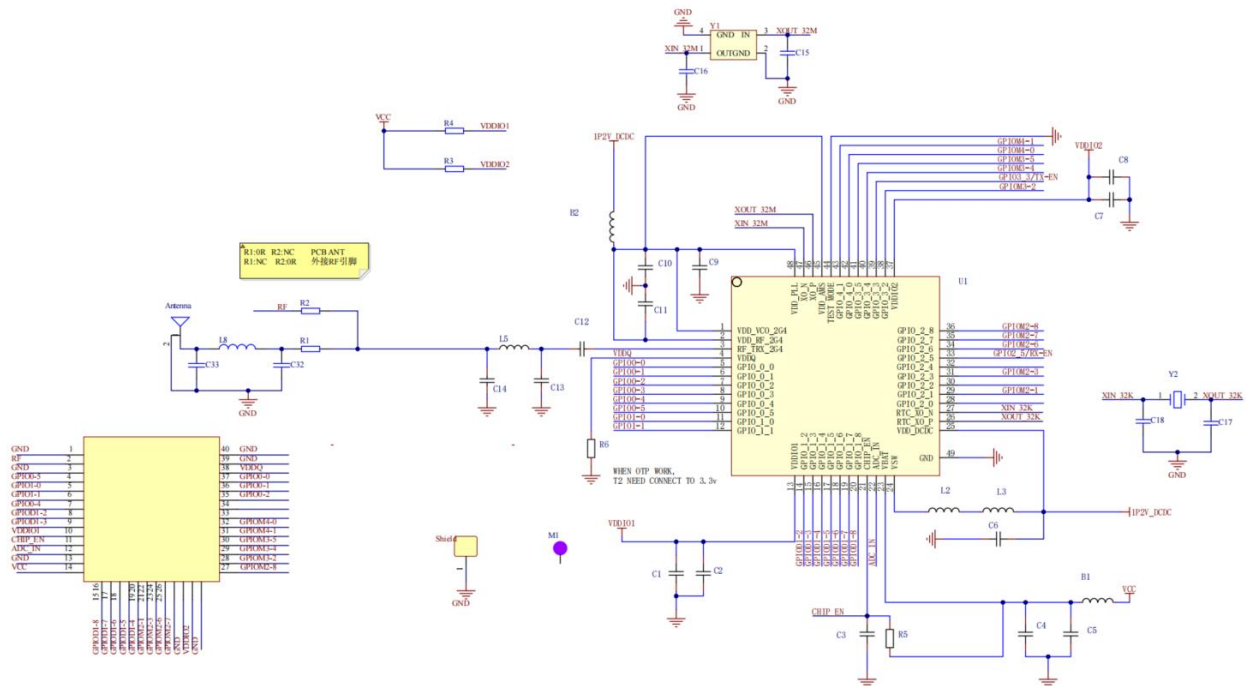

Notice: Before placing an order, please confirm the specific configuration required with the salesperson.

7 PCB Layout

Module antenna area couldn't have GND plane or metal cross line, couldn't place components nearby. It is better to make hollow out or clearance treatment or place it on the edge of PCB board.

Notice: Refer to examples as below, and highly suggest to use the first design and the adjustment of modules antenna design according to the first wiring.

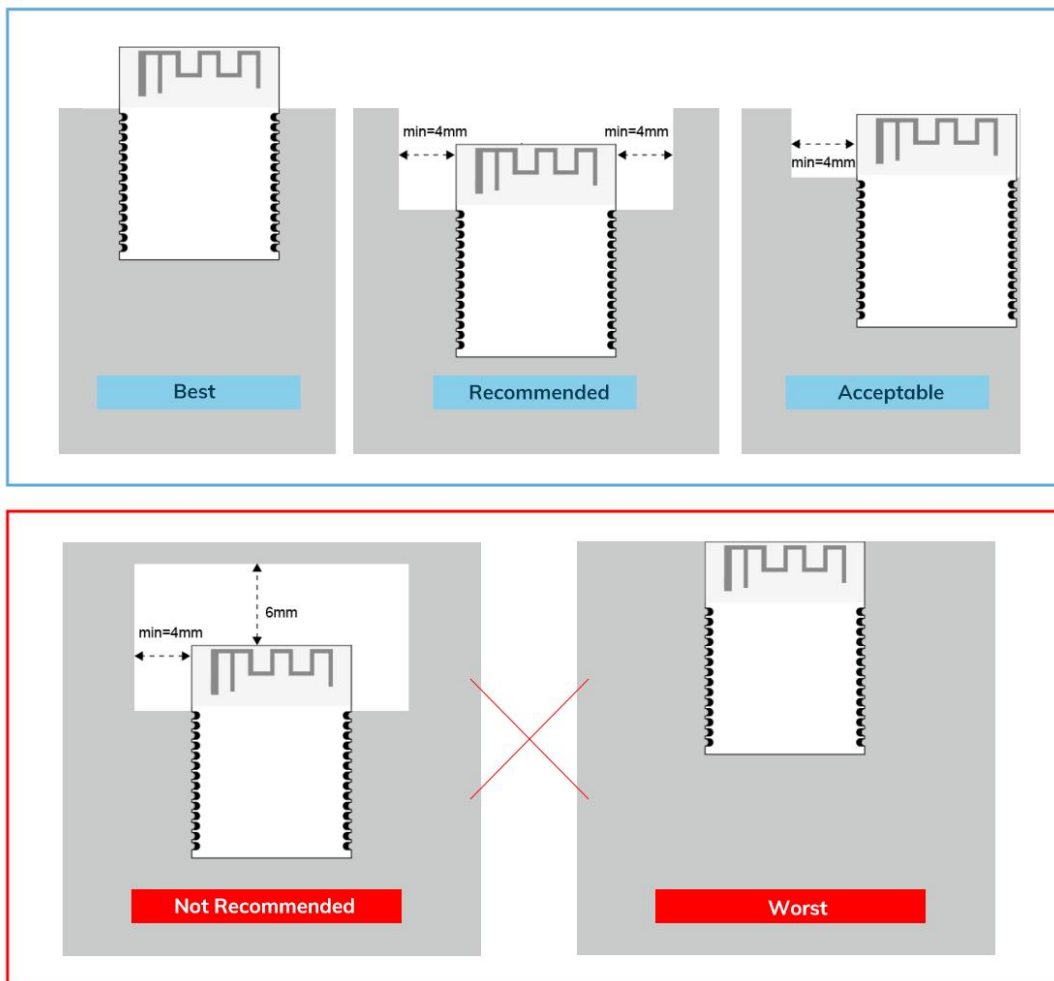

Layout notes:

- 1) Preferred Module antenna area completely clearance and not be prevented by metals, otherwise it will influence antenna's effect (as above DWG. indication).
- 2) Cover the external part of module antenna area with copper as far as possible to reduce the main board's signal cable and other disturbing.
- 3) It is preferred to have a clearance area of 4 square meter or more area around the module antenna (including the shell) to reduce the influence to antenna.
- 4) Device should be grounded well to reduce the parasitic inductance.
- 5) Do not cover copper under module's antenna in order to avoid affect signal radiation or lead to transmission distance affected.
- 6) Antenna should keep far from other circuits to prevent radiation efficiency reduction or affects the normal operation of other lines.
- 7) Module should be placed on edge of circuit board and keep a distance away from other circuits.
- 8) Suggesting to use magnetic beads to insulate module's access power supply.

8 Reflow and Soldering

1) Do SMT according to above reflow oven temperature deal curve. Max. Temperature is 260°C;

Refer to IPC/JEDEC standard; Peak TEMP<260°C; Times: ≤2 times, suggest only do once reflow soldering on module surface in case of SMT double pad involved. Contact us if special crafts involved.

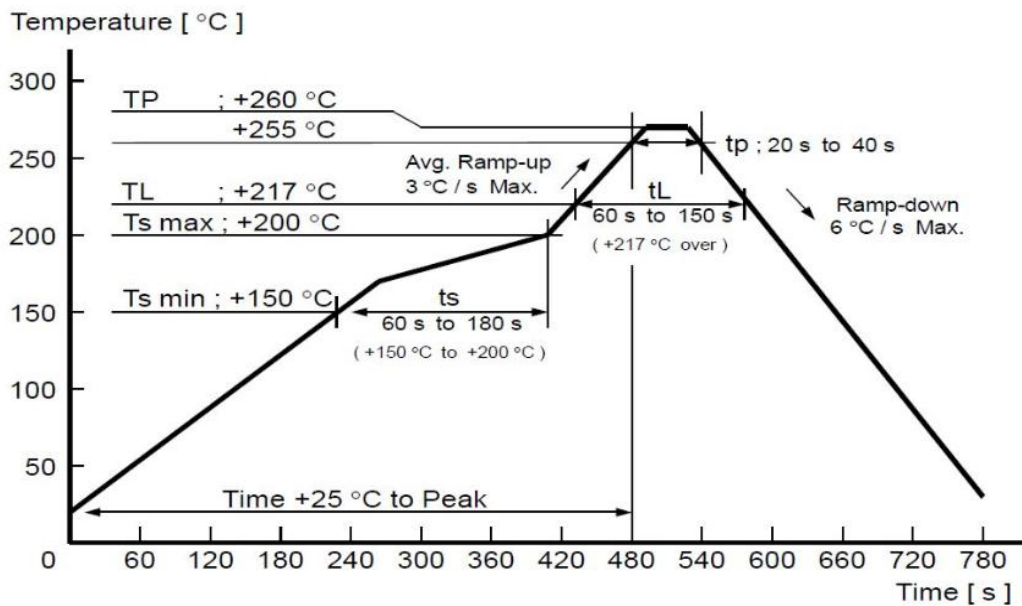

- 2) Suggesting to make 0.2mm thickness of module SMT for partial ladder steel mesh, then make the opening extend 0.8mm
- 3) After unsealing, it cannot be used up at one time, should be vacuumed for storage, couldn't be exposed in the air for long time. Please avoid getting damp and soldering-pan oxidizing. If there are 7 to 30 days interval before using online SMT, suggest to bake at 65-70 °C for 24 hours without disassembling the tape.
- 4) Before using SMT, please adopt ESD protection measure.

9 Package Information

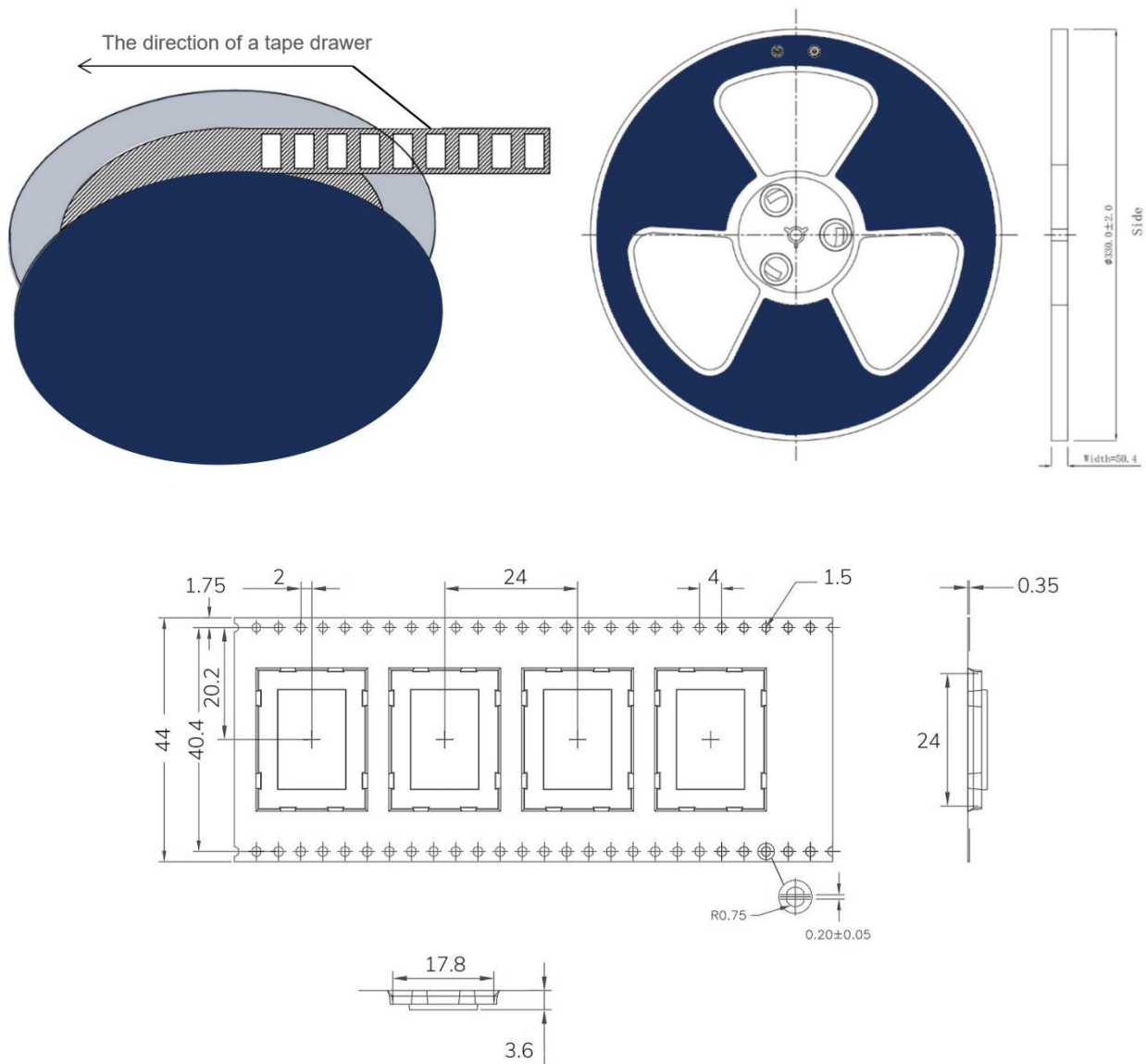

* (Default unit: mm Default tolerance: ± 0.1)

Packing detail	Specification	Net weight	Gross weight	Dimension
Quantity	650PCS	680g	1500g	W=44mm, T=0.35mm

* **Note:** Default weight tolerance all are within 10g (except the special notes)

10 Ordering Information

Ordering Model	Chip Type	Sizes	Flash	RAM
MS56SFA1-001	IN610	23.2x17.4x2mm	512KB	256 KB ROM 96 KB SRAM
MS56SFA1-002	IN628E	23.2x17.4x2mm	512KB	384 KB ROM 184 KB SRAM

● Quality

Cognizant of our commitment to quality, we operate our own factory equipped with state-of-the-art production facilities and a meticulous quality management system. We hold certifications for ISO9001, ISO14001, ISO27001, OHSAS18001, BSCI.

Every product undergoes stringent testing, including transmit power, sensitivity, power consumption, stability, and aging tests. Our fully automated module production line is now in full operation, boasting a production capacity in the millions, capable of meeting high-volume production demands.

● Contact Us

Shenzhen Minewsemi Co., Ltd. is committed to swiftly delivering top-quality connectivity modules to our customers. For assistance and support, please feel free to contact our relevant personnel, or contact us as follows:

Web: www.minewsemi.com

Email: minewsemi@minew.com

Linkedin: www.linkedin.com/company/minewsemi

Shop: <https://minewsemi.en.alibaba.com/>

Tel: +86 0755-28010353

Address: 3rd Floor,I Building, Gangzhilong Science Park, NO.6, Qinglong Road,Longhua District, Shenzhen, China

Click the icon to view and download the latest product documents electronically.



Related documents: Chip specification

● Copyright Statement

This manual and all the contents contained in it are owned by Shenzhen Minewsemi Co., Ltd. and are protected by Chinese laws and applicable international conventions related to copyright laws.

The certified trademarks included in this product and related documents have been licensed for use by MinewSemi. This includes but is not limited to certifications such as BQB, RoHS, REACH, CE, FCC, BQB, IC, SRRC, TELEC, WPC, RCM, WEEE, etc. The respective textual trademarks and logos belong to their respective owners. For example, the Bluetooth® textual trademark and logo are owned by Bluetooth SIG, Inc. Other trademarks and trade names are those of their respective owners. Due to the small size of the module product, the "@" symbol is omitted from the Bluetooth Primary Trademarks information in compliance with regulations.

The company has the right to change the content of this manual according to the technological development, and the revised version will not be notified otherwise. Without the written permission and authorization of the company, any individual, company, or organization shall not modify the contents of this manual or use part or all of the contents of this manual in other ways. Violators will be held accountable in accordance with the law.

MINEWSEMI

Tel: 0086-755-2801 0353

Email: minewsemi@minew.com

Web: www.minewsemi.com

Address: 3rd Floor, Building I, Gangzhilong Science Park, Qinglong Road, Longhua District, Shenzhen, 518109, China

